

THE PROPERTY OF THE DRAWING IS ESTABLISHED BY LAW. IT IS FORBIDDEN TO PRODUCE OR SHOW IT TO THIRD PARTY, WITHOUT A WRITTEN AGREEMENT.

Item	Name	Q.ty
1	CA.GWP.5.35	2
2	KPLX.2518	1
3	R.5.SCH	4
4	V.TCE5x14	4

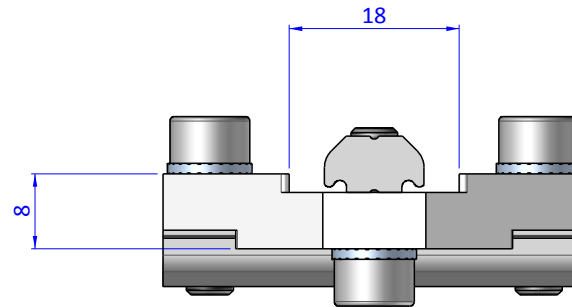
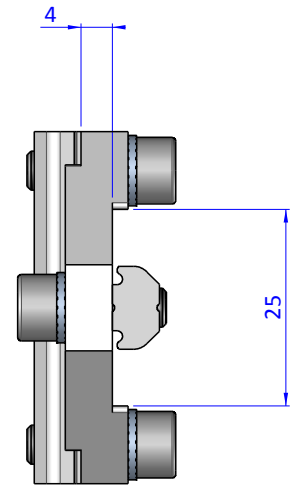
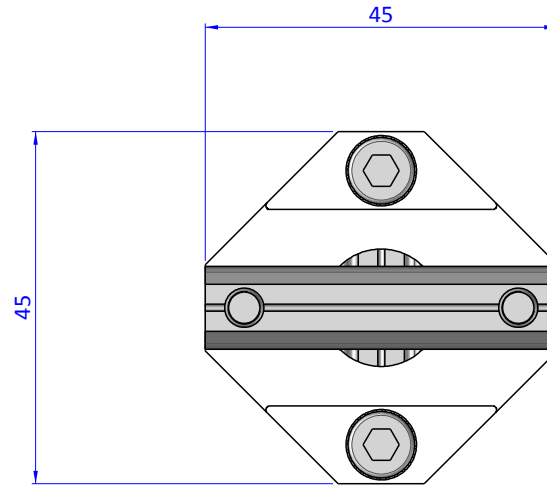
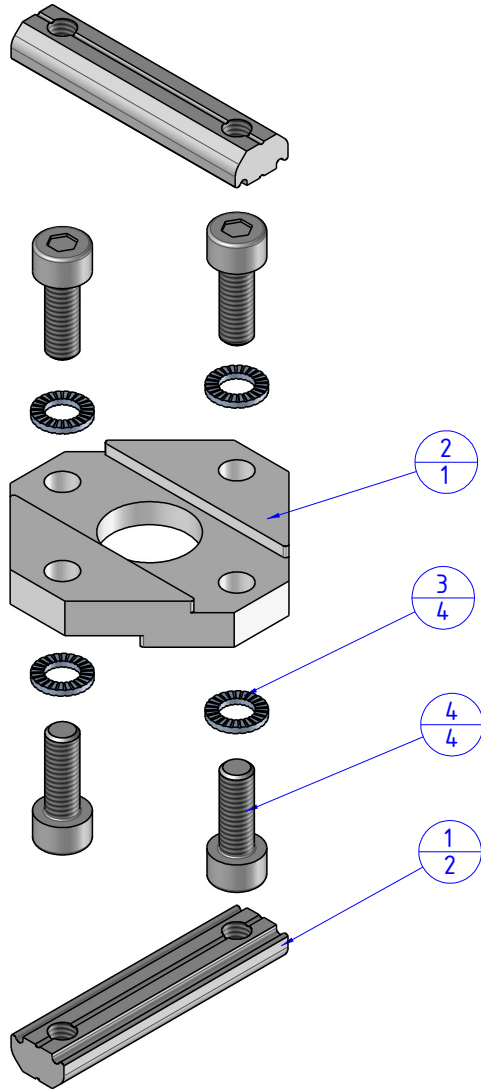

Format A3

UNI 936-76

		DESIGNED FROM	REVIEW
		FP SERVICES	A
GENERAL TOLERANCE	DESCRIPTION	DATE	WEIGHT
UNI - ISO 2768	CA.KPLX.2518	30/04/2016	0,072kg
CLASSE f		CODE	CA.KPLX.2518